

*English*



 **AccuVein<sup>®</sup>**

**AccuVein AV500 User Manual**

A health professional's guide for use  
and operation of the AccuVein AV500

This AV500 User Manual and additional information can also be downloaded from [www.accuvein.com](http://www.accuvein.com)



AV500 is manufactured for AccuVein Inc.  
AccuVein Inc.  
3243 Route 112  
Bldg. 1 Ste 2  
Medford, NY 11763  
United States of America  
[www.accuvein.com](http://www.accuvein.com)  
Phone: (816) 997-9400



Device fully complies with  
European Directive 2002/364/  
EC. Conformité Européenne

Australian Sponsor:  
Emergo Australia  
Level 20, Tower II  
Darling Park  
201 Sussex Street  
Sydney, NSW 2000  
Australia

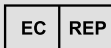

EMERGO EUROPE  
Prinsessegracht 20  
2514 AP The Hague  
The Netherlands

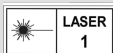

**520nm / 830nm**  
**485nJ / 270nJ**  
**IEC/EN 60825-1:2014**

IEC/EN 60825-1:2014  
Class 1 laser device  
Wavelength: 520nm and 830nm  
485nJ and 270nJ per pulse in train

For United States of America customers: Complies with 21 CFR 1040.10 and 1040.11 except for deviations pursuant to Laser Notice No. 50, dated June 24, 2007

AccuVein® is the registered trademark of AccuVein Inc. The content of this manual including all photographs and drawings is the proprietary information of AccuVein Inc.

This manual last revised: January 2019

## Warnings and Cautions

Read all instructions, cautions, and warnings prior to use. This product should be operated only by qualified medical professionals. The AV500 should not be used as the sole vein location method, and it is not a substitute for sound medical judgment and the visual and tactile location of veins.

Before using the AV500 on a patient, qualified medical professionals must read and understand this AV500 User's Manual. Before first use, users should compare how the AV500 detects veins with visual detection and palpation techniques.

English

# AccuVein® AV500 User Manual

A health professional's guide for use and operation of the AccuVein AV500

### Basic use and operation

5

Setup  
Intended Use  
Product Description

### Charging, cleaning, and disposal

8

Charging the AV500  
Cleaning and Disinfecting  
Disposal

### Troubleshooting and Service

11











Alerts  
Faults

### Product Label Specifications

14

Labeling  
Specifications  
Environment

# Symbols

	Safety Alert. Indicates a potential personal injury hazard Warning: Indicates a hazardous situation, which if not avoided, could result in death or serious injury Caution: Indicates a hazardous situation that if not avoided may result in minor or moderate injury.
	Refer to instruction manual
	Laser light The AV500 emits laser radiation
	Type B Applied Part
	Conformité Européenne (European Conformity). This symbol means that the device fully complies with European Directive 93/42/EEC
	ETL Classified means that most system elements conform to IEC standard 60601-1
	Product Serial Number
	Reference to Catalog Model Number
	European Representative
	Manufacturer
	European Union Waste Electrical and Electronic Equipment Directive Logo. Return is allowed for proper disposal.

	Temperature limitation
	Humidity limitation
	Do not use if package is damaged
	Keep dry
	Fragile, handle with care
	Reusable packaging
	Recyclable packaging
	Direct Current. Example: 5.0 V indication of charging voltage
	Manufacturing date

### Patient and User Safety—Warnings

**WARNING:** The AV500 enables location of certain superficial veins and is not a substitute for sound medical judgment based on the visual and tactile location and assessment of veins. The AV500 should be used only as a supplement to the judgment of a qualified professional.

**WARNING:** The AV500 should only be operated when its battery is sufficiently charged (indicated when the battery icon on the LCD screen is green), or when the device is operated in a powered hands-free accessory to ensure AV500 is available for use.

**WARNING:** AV500 vein location is dependent on a variety of patient factors and may not display veins on patients with deep veins, skin conditions, hair, scarring or other highly contoured skin surface, and adipose (fatty) tissue.

**WARNING:** The AV500 displays only superficial veins and does so only to limited depths dependent on a variety of patient factors. The AV500 does not indicate vein depth.

**WARNING:** The AV500 emits Visible and Invisible laser radiation. Do not stare into beam.

**WARNING:** Stop using the AV500 if the green light does not turn on when the side purple button is pushed.

**WARNING:** Do not hold the AV500 while performing venipuncture or other medical procedures.

**WARNING:** For external use only.

**WARNING:** Keep the AV500 and its battery out of the reach of children.

**WARNING:** To view vein location accurately, you must position the AV500 directly over the center of the vein being assessed.

### Patient and User Safety—Contraindications

**WARNING:** The AV500 should not be used to locate veins in the eyes.

**WARNING:** The AV500 is not intended to be used as a diagnostic device or for treatment of any kind.

### Patient and User Safety—Cautions

**CAUTION:** United States Federal law restricts this device to sale by or on the order of a physician or other qualified medical professional.

**CAUTION:** Operation or use of the AV500 in a manner different than specified in this AV500 User's Manual may result in hazardous laser light exposure.

### Equipment Care—Warnings

**WARNING:** Do not immerse the AV500 or the AV500 charging cradle in liquid or wet the AV500 such that liquid spills off.

**WARNING:** Do not attempt to open, disassemble, or service the battery pack. Do not crush, puncture, or dispose of the battery in fire or water. Do not short external contacts. Do not expose to temperature above 60°C / 140°F.

**WARNING:** Do not modify in any way the interior or exterior components of the AV500.

**WARNING:** To reduce the risk of fire or shock hazard and interference, use only the recommended accessories and do not expose this equipment to rain or heavy moisture.

**WARNING:** Use only AccuVein accessories and replacement parts with the AV500. The use of non AccuVein accessories may degrade safety.

**WARNING:** Use of this equipment adjacent to or stacked with other equipment should be avoided because it could result in improper operation. If such use is necessary, this equipment and the other equipment should be observed to verify that they are operating normally.

**WARNING:** Use of accessories other than those specified or provided by the manufacturer of this equipment could result in increased electromagnetic emission, decreased electromagnetic immunity of this equipment or result in improper operation.

**WARNING:** Portable RF communications equipment (including peripherals such as antenna cables and external antennas) should be used no closer than 30 cm to any part of the AV500, CC500 or HF570. Such equipment use inconsistent with this recommendation could result in degradation of the product performance.

### Equipment Care—Cautions

**CAUTION:** Use only AccuVein approved and branded battery charging accessories and additional accessories.

**CAUTION:** Electromagnetic Interference (EMI) can affect the proper performance of the device. Normal operation can be restored by removing the source of the interference.

**CAUTION:** Do not attempt to sterilize the AV500 with heat or pressure sterilization methods.

**CAUTION:** The AV500 will not display veins if operated outside its temperature range.

**CAUTION:** The AV500 may not display veins if operated under bright light such as sunlight.

**CAUTION:** Do not disassemble or modify the AV500 or any of its charging accessories.

**CAUTION:** Do not self-service. The AV500 contains no customer serviceable components. The AV500 and its accessories should be serviced only by an authorized AccuVein repair department.

### Setup

---

The AV500 needs to be placed in the charging cradle before first use. AccuVein recommends fully charging the AV500 at that time. Connect the charging cradle to the power supply. The AV500 comes with power supply adaptors to ensure outlet compatibility. If necessary, secure a different power adaptor to the power supply before plugging it into an outlet. The AV500 is compatible with all voltages from 100 – 240VAC.

Remove the plastic protective cover from the AV500 display screen before use.

### Intended Use

---

The AccuVein AV500 is a portable, hand-held instrument that helps medical professionals to locate certain superficial veins. The AV500 is intended to be used as a supplement to appropriate medical training and experience. The AV500 should not be used as the sole method for locating veins, and should be used only by a qualified medical professional, who should do so either prior to palpation to help identify the location of a vein, or afterwards to confirm or refute the perceived location of a vein. When using the AV500, medical practitioners should always follow the appropriate medical protocols and practices as required by their medical facility, as well as exercise sound medical judgment.

When used properly, the AV500 enables users to locate certain superficial veins in connection with medical procedures, such as venipuncture.

The AV500 can be used whenever the determination of vein location is appropriate such as hospitals and clinics.

### Product Description

---

The AV500 operates by using infrared light to detect veins beneath the skin, then projecting the position of the veins on the skin surface directly above the veins. Qualified medical personnel can observe the vasculature as displayed to assist them in finding a vein of the right size and position for venipuncture and other medical procedures requiring the location of superficial veins. No training is required to operate the AV500.

The AV500 only shows superficial vasculature. The maximum depth that veins are displayed varies by patient. In addition, some patients' veins or a portion of their veins might not be displayed well or at all. Causes for less than optimal or lack of vein display include, but are not limited to, vein depth, skin conditions (e.g., eczema, tattoos), hair, scarring or other highly contoured skin surface, and adipose (fatty) tissue.

When held directly overhead, the AV500 accurately locates the center of a vein. Increasing the displacement from directly overhead results in an offset in the displayed vein position. Width of displayed vein may differ from the actual width depending on patient to patient differences and vein width. The center line of the vein is accurate when the device is being used correctly and should always be used as the target when performing venipuncture or other medical procedures.

The AV500 requires no routine or preventative maintenance.

The AV500 is portable, internally powered by battery and approved for continuous operation. The AV500 is considered a Type B applied part.

The technology in the AV500 is patented. Visit [www.accuvein.com](http://www.accuvein.com) for the most current information.





## Basic use and operation

### Power on/off – side button

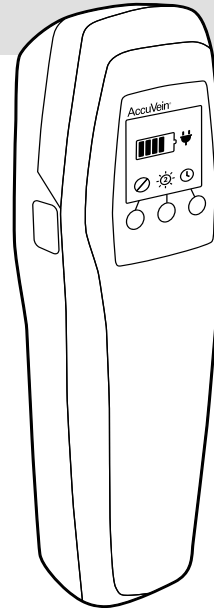
The purple button located on the left side of the AV500 will power on the AV500 and turn on the vein display light. Press the button again to turn the vein display light and device off.

Press the purple side button again to turn the vein display light back on and begin locating veins again.



AV500 controls at a glance		
	Operate the device	
	<b>Inverse setting</b> Left button	The inverse setting inverts the vein projection such that the veins can be depicted by either green light over veins or darkness over veins and green light where veins do not appear. Changing the inverse setting may improve vein visibility and eye comfort level. Use the left button to invert the projection.
	<b>Projection intensity</b> Middle button 1 Low 2 Normal 3 Bright	The brightness of vein projection can be controlled using the brightness button.
	<b>Time-out setting</b> Time before unit automatically shuts off Right button 15 minute time out $\infty$ no time out	The time-out setting determines the amount of time until the vein display light turns off. This setting may help increase battery operation time of the AV500. To set the time, press the right button to go into the time-out menu. The time out can be set to $\infty$ (no time-out) or 15 minutes.

### Positioning the AV500

Hold the device from 6–10" (150 to 250 mm) over the surface of the skin. Scan the area of interest to view. Once a vein is selected, make sure the vein display light is centered directly above the vein's center line. Tilting the device to either side of the vein will offset the projected vein from its true location beneath the skin. You can often enhance display quality by slightly adjusting the height and angle to the skin. In particular, moving the device closer or further from the skin can help bring additional veins into view, depending on the patient's vasculature, room lighting, and depth of the veins.

**⚠ WARNING:** To view vein location most accurately, you must position the AV500 directly over the center of the vein being assessed.

**⚠ WARNING:** Vein projection width is most accurate when the AV500 is positioned closest to the body.

**⚠ CAUTION:** The AV500 projection may not display veins if operated under bright light such as bright sunlight

### Assess the Vasculature

While the vein display light is on, shine the AV500 over the patient's skin. You can do this before palpation, scanning quickly over the skin to help narrow down possible locations, or after palpation has confirmed vein location and suitability.

You can then often see veins better by rotating the AV500 slightly on its axis and moving the device closer to or further away from the skin.

### Confirm the Vein

After assessing the patient's vasculature, confirm the site for your procedure by verifying the location and suitability of the vein using normal medical techniques and good medical judgment, such as vein visualization, palpation, and other medical techniques.

An AccuVein hands-free accessory allows you to keep your hands free to perform medical procedures. You can also hand the AV500 to an assistant during the procedure. The AV500 should be used only by qualified medical professionals and only in conjunction with appropriate visual and tactile vein assessment techniques.

# Charging the AV500

Verify the charging cradle is properly connected (see the Setup section). Place the AV500 in the charging cradle with the LCD facing outward to begin charging. A battery charge icon will display when the AV500 is charging. The light on the charging cradle will only turn on when a device is detected. If the light turns on when there is no device placed in the charging cradle please call AccuVein support for assistance.

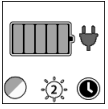
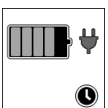
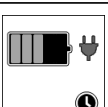
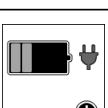
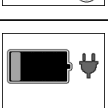
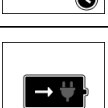
	Operate the device in powered hands-free stand
	80% to 100% charge
	60% to 80% charge
	40% to 60% charge
	20% to 40% charge
	Inoperable due to low charge

To ensure the battery remains charged and ready for use, you can store the AV500 in its charging cradle or a powered AccuVein hands-free accessory. The AV500 battery cannot be overcharged when approved charging devices are used.

**⚠ CAUTION:** Use only the AccuVein P510 power supply with the CC500 cradle or other AccuVein approved accessories.

When the AV500 battery gets low the battery indicator will flash yellow or red and beep repeatedly. Before the battery is completely depleted, an alert requesting to charge the battery will be displayed on the screen. The AV500 will resume normal operation once it has been charged.

In normal operation, the AV500 battery is expected to be replaced about every two or three years. Battery life depends on factors such as usage times, temperature of the device, and number of charging cycles. Longer charge cycles or shorter operating periods are indications that the battery should be replaced.

To replace the battery the device can be returned to an AccuVein approved facility approved to perform a battery replacement.

*The AV500 requires no periodic maintenance, field calibration, and is not field repairable.*



### Cleaning and Disinfecting

---

**⚠ WARNING:** Users should inspect the AV500 and clean and disinfect the AV500 as required by their institution's policies to ensure that it is sufficiently clean before each use.

**⚠ WARNING:** Do not use AV500 if the vein illumination window is scratched or dirty. The AV500 should be returned to AccuVein for servicing if the vein light window is scratched.

For peak performance, the optical surfaces and lenses on the back of the AV500 should be kept clean. Use alcohol wipes or any soft lens wipe with several drops of 70% isopropyl alcohol. Dirt or scratches on the vein display window show up as dark shadows in the vein projection.

To clean the body of the AV500 and its accessories, you may use an AccuVein approved cleaner using AccuVein's and the manufacturer's instructions. Below are some approved cleaners. For a full list of approved and unapproved cleaning materials and procedures visit the AccuVein website

[www.accuvein.com/clean](http://www.accuvein.com/clean)

PDI Super Sani-Cloth, PDI Sani-Cloth Plus, Pre-moistened bleach wipes (10% or less), Caviwipes1 or Cavicide1, Cidex Plus, T-Spray II, Birex, Incides N, Incidin Plus, Incidin Pro, EcoLab SaniCloth Active

**Do not** immerse the AV500, the AV500 charging cradle, or the AV500 hands-free accessories in liquid or get the AV500 or its components wet such that liquid spills off. Do not attempt to sterilize the AV500 with heat or pressure sterilization methods.

**Do not** clean the AV500 while in a charging cradle or hands-free accessory.

**Do not** clean the AV500 when the battery cover is removed.

Unplug the charging cradle before cleaning the cradle.

### Disposal

---

As required by the WEEE (Waste Electrical and Electronic Equipment Directive) of the European Community and other national laws, AccuVein offers all end users the possibility to return "end of life" units without incurring disposal charges.

- The offer is valid for AccuVein electrical and electronic equipment
- The unit needs to be complete, not disassembled and not contaminated.

If you wish to return an AccuVein product for waste recovery please contact AccuVein customer service.

#### **Waste Treatment is Your Responsibility**

If you do not return an "end of life" unit to AccuVein you must hand it to a company specialized in waste recovery. Do not dispose of a unit in a litter bin or at a public waste disposal site.

It is well known that certain materials pollute the environment by releasing toxic product during decomposition. The aim of the RoHS directive is to reduce the content of toxic substance in electronic products in the future. AccuVein's business practice is for each product to meet the RoHS directive.

The intent of the WEEE directive is to enforce the recycling of electrical/electronic waste. By controlling recycling of end of life products AccuVein seeks to avoid the negative impacts of its products on the environment.

## Accessories

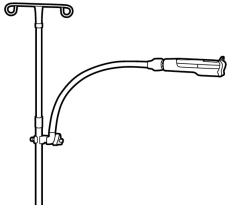
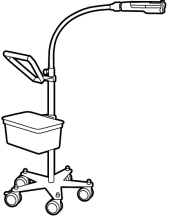
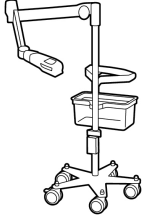

The AV500 Vein Visualization System includes an AV500 vein illuminator with integrated rechargeable battery, a charging cradle, power supply, and instructional documents.

AccuVein offers optional hands-free stands that many practitioners find useful. For information about these and other optional accessories visit the AccuVein website [www.accuvein.com](http://www.accuvein.com).

	<p><b>HF510</b> Unpowered hands-free arm with clamp</p>
	<p><b>HF550</b> Unpowered wheeled hands-free arm</p>
	<p><b>HF570</b> Powered wheeled hands-free arm</p>

### Faults & Alerts

The AV500 will alert the user if it is not able to operate.

 <p><b>AV01234567</b></p>	<p><b>Fault</b></p> <p>Unit faulted. Contact AccuVein Customer Support.</p> <p>For all service needs inside the USA, contact AccuVein customer support via telephone at (888) 631-6180. For customer inquiries outside the United States, please contact your local approved distributor or send an email to <a href="mailto:international-service@accuvein.com">international-service@accuvein.com</a>.</p>
 <p><b>AV01234567</b></p>	<p><b>Too Cold Alert</b></p> <p>Unit too cold. Bring the device above 4°C/39°F</p>
 <p><b>AV01234567</b></p>	<p><b>Too Hot Alert</b></p> <p>Unit too hot. Bring the device below 33°C/90°F</p>

### Charging Issues

- Check that the device is plugged into an approved AccuVein charging accessory.
- If the light on the charging cradle does not turn on, the problem lies within the charging accessories.

### Service

If the AV500 detects that it cannot operate properly, it turns off the vein display light and displays an alert or fault screen.

When the AV500 is not operating properly turn the device off using the side purple power on/off button.

Alerts appear if you operate the device in an environment that is too cold (less than 4°C/39°F) or too hot (more than 33°C/90°F). Should a temperature alert occur, simply bring the AV500 back within its operating temperature range.

If the fault screen appears, you should stop using the AV500 immediately. Turn off the device and contact AccuVein Customer support. They may ask for the serial number and fault code that appears on the fault screen.

For all customer service needs inside the USA, contact AccuVein customer support via telephone at (888)631-6180. For customer inquiries outside the United States, please contact your local approved distributor or send an email to [international-service@accuvein.com](mailto:international-service@accuvein.com).

Guidance and Manufacturer's Declaration—Electromagnetic Immunity			
The AV500 is intended for use in the electromagnetic environment specified below. The customer or the user of the AV500 should assure that it is used in such an environment.			
Immunity Test	IEC 60601 test level	Compliance level	Electromagnetic environment – guidance
Electrostatic discharge (ESD) IEC 61000-4-2	±6kV Contact ±8kV Air	±6kV Contact ±8kV Air	Floors should be wood, concrete, or ceramic tile. If floors are covered with synthetic material, the relative humidity should be at least 30 %.
Electrical fast transient/burst IEC 61000-4-4	±2kV for power supply lines ±1kV for input/output lines	±2kV for power supply Lines ±1kV for input/output lines	Mains power quality should be that of a typical commercial or hospital environment.
Surge IEC 61000-4-5	±1kV line(s) to line(s) ±2kV line(s) to earth	±1kV line(s) to line(s) ±2kV line(s) to earth	Mains power quality should be that of a typical commercial or hospital environment.
Voltage dips, short interruptions and voltage variations on power supply input lines IEC 61000-4-11	<5% UT >95% dip for 0.5 cycle 40% UT 60% dips 70% UT 30% dip		Mains power quality should be that of a typical commercial or hospital environment. If the user of the AV500 requires continued operation during power mains interruptions, it is recommended that the AV500 be powered from an uninterruptible power supply or a battery.
Power frequency (50/60 Hz) magnetic field IEC 61000-4-8	3 A/m	3 A/m	Power frequency magnetic fields should be at levels characteristic of a typical location in a typical commercial or hospital environment.

NOTE: UT is the a.c. mains voltage prior to application of the test level.

Guidance and Manufacturer's Declaration – Electromagnetic Immunity			
The AV500 is intended for use in the electromagnetic environment specified below. The customer or the user of the AV500 should assure that it is used in such an environment.			
Immunity Test	IEC 60601 Test Level	Compliance Level	Electromagnetic Environment
Conducted RF IEC 61000-4-6	3 Vrms 150 kHz to 80 MHz	3 Vrms	Portable and mobile RF communications equipment should be used no closer to any part of the AV500, including cables, than the recommended separation distance calculated from the equation applicable to the frequency of the transmitter. Recommended separation distance where P is the maximum output power rating of the transmitter in watts (W) according to the transmitter manufacturer and d is the recommended separation distance in meters (m). Field strengths from fixed RF transmitters, as determined by an electromagnetic site survey, should be less than the compliance level in each frequency range. Interference may occur in the vicinity of equipment marked with the following symbol: ☒
Radiated RF IEC 61000-4-3	3 V/m 80 MHz to 2.5 GHz	3 V/m	
NOTE 1 At 80 MHz and 800 MHz, the higher frequency range applies.			
NOTE 2 These guidelines may not apply in all situations. Electromagnetic propagation is affected by absorption and reflection from structures, objects, and people.			
Field strengths from fixed transmitters, such as base stations for radio (cellular/cordless) telephones and land mobile radios amateur radio, AM and FM radio broadcast and TV broadcast cannot be predicted theoretically with accuracy. To assess the electromagnetic environment due to fixed RF transmitters, an electromagnetic site survey should be considered. If the measured field strength in the location in which the AV500 is used exceeds the applicable RF compliance level above the AV500 should be observed to verify normal operation. If abnormal performance is observed, additional measures may be necessary, such as re-orienting or relocating the AV500. Over the frequency range 150 kHz to 80 MHz, field strengths should be less than 3 V/m.			

Recommended separation distances between portable and mobile RF communications equipment and the AV500			
The AV500 is intended for use in an electromagnetic environment in which radiated RF disturbances are controlled. The customer or the user of the AV500 can help prevent electromagnetic interference by maintaining a minimum distance between portable and mobile RF communications equipment (transmitters) and the AV500 as recommended below, according to the maximum output power of the communications equipment.			
Rated Maximum Output power of transmitter, W	Separation distance according to frequency of transmitter, m		
	150kHz to 80MHz D = 1.2P	80MHz to 800MHz	800MHz to 2.5GHz
0.01	0.12	0.12	0.12
0.1	0.38	0.38	0.38
1	1.2	1.2	1.2
10	3.8	3.8	3.8
100	12	12	12
For transmitters rated at a maximum output power not listed above, the recommended separation distance $d$ in meters (m) can be estimated using the equation applicable to the frequency of the transmitter, where $P$ is the maximum output power rating of the transmitter in watts (W) according to the transmitter manufacturer. NOTE 1 At 80 MHz and 800 MHz, the separation distance for the higher frequency range applies. NOTE 2 These guidelines may not apply in all situations. Electromagnetic propagation is affected by absorption and reflection from structures, objects, and people.			

Guidance and Manufacturer's Declaration—Electromagnetic Emissions		
The AV500 is intended for use in the electromagnetic environment specified below. The customer or the user of the AV500 should assure that it is used in such an environment.		
Emissions Test	Compliance	Electromagnetic Environment Guidance
RF Emissions CISPR 11	Group 1	The AV500 uses RF energy only for its internal function. Therefore, its RF emissions are very low and are not likely to cause any interference in nearby electronics.
RF Emissions CISPR 11	Class A	The AV500 is suitable for use in all establishments other than domestic and those directly connected to the public low-voltage power supply network that supplies buildings used for domestic purposes.
Harmonic Emissions IEC 6100-3-2	Complies	
Voltage Fluctuations IEC 6100-3-3	Complies	

# Product labels

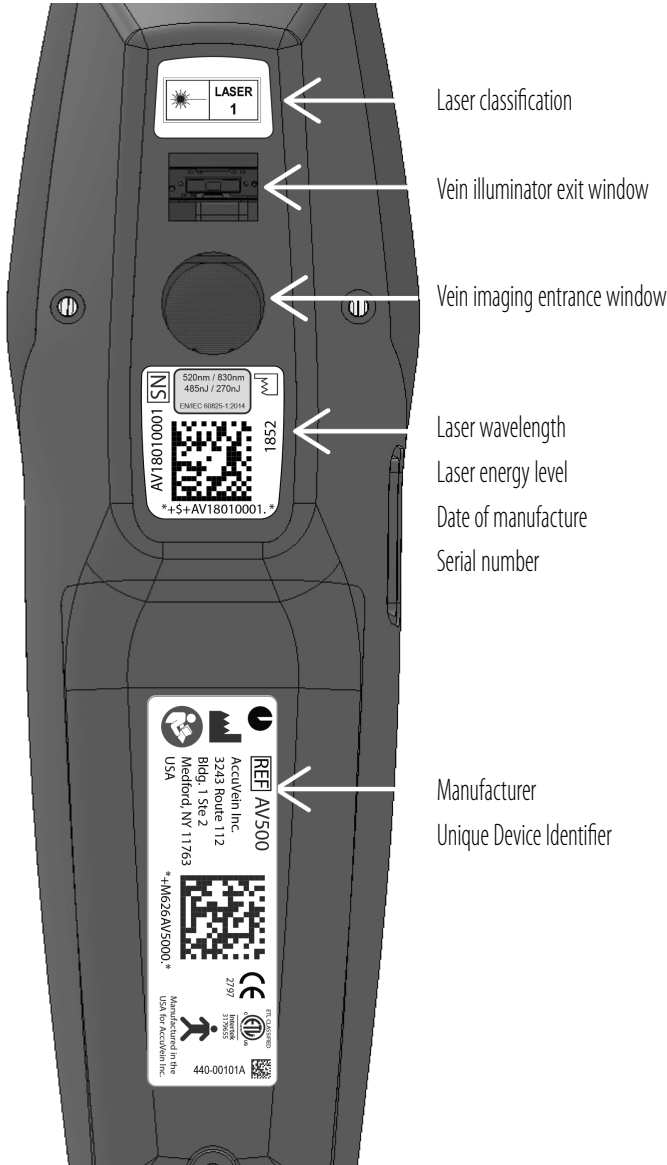

## Description

Weight	275 grams (9.7 oz.)
Size	5 x 6 x 20 cm (2" x 2.4" x 7.9")
Integrated Battery, BA500	Product contains integrated Li-Ion battery. 3.6V, 3,100 mAh
Continuous (vein light on) run time on full charge:	Typically, 120 minutes
Maximum charging time	Charging battery from 5% charged to 100% 3 hours 45 minutes
CC500 desktop charging cradle + PS510 power supply	5V 2.0A 100V-240V 50Hz-60Hz 0.4A
Product sealing	Dust / liquid IPx0

## Environment

Operating	Temperature	4°C to 33°C (39°F to 90°F)
	Humidity	5% to 85% RH non-condensing
	Pressure	75kPa to 106kPa
Transport	Temperature	-20°C to 50°C (-4°F to 122°F)
	Humidity	5% to 85% RH non-condensing
Storage	Temperature	-20°C to 50°C (-4°F to 122°F)
	Humidity	5% to 85% RH non-condensing



AccuVein Inc.

3243 Route 112

Bldg. 1 Ste 2

Medford, NY 11763

[www.accuvein.com](http://www.accuvein.com)

Phone: +1(816) 997-9400

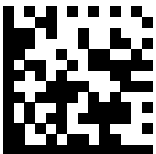

745-00001A